



New Product

AELIO-P50B100
AELIO-P50B200

C&I Hybrid ESS Solution



Version: V1.1
Dept.: Marketing
Date: Jan. 18

CONTENTS

Overview

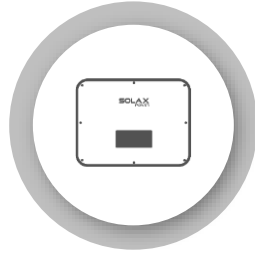

Technical Parameter

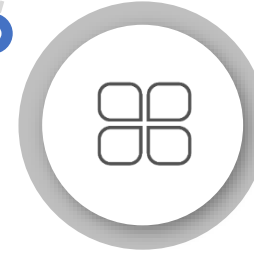

Key Features



Effortless O&M

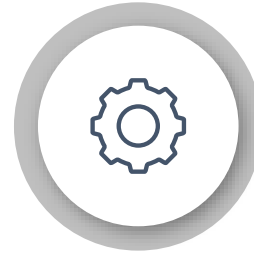

Application Systems



Air Cooling Intelligent Energy Storage System Design for C&I

- ALL IN ONE Solution



100kWh stand-alone capacity



200kWh stand-alone capacity

AELIO means the son of the sun and the LIO (lion) is the king of beasts, so Aelio means the king of solar & electricity.

AELIO contains both integrated cabinet and split design solutions.

1. The cabinet solution has 100kWh and 200kWh types with 50kW inverter equipped by default for each type.
2. The split solution includes a battery rack that can be equipped with 7-14 batteries with 14.3kWh for each. The 50kW hybrid inverter with natural cooling can be wall-mounted.

Air Cooling Intelligent Energy Storage System Design for C&I

● 2h

● 4h

● 6h

● 8h

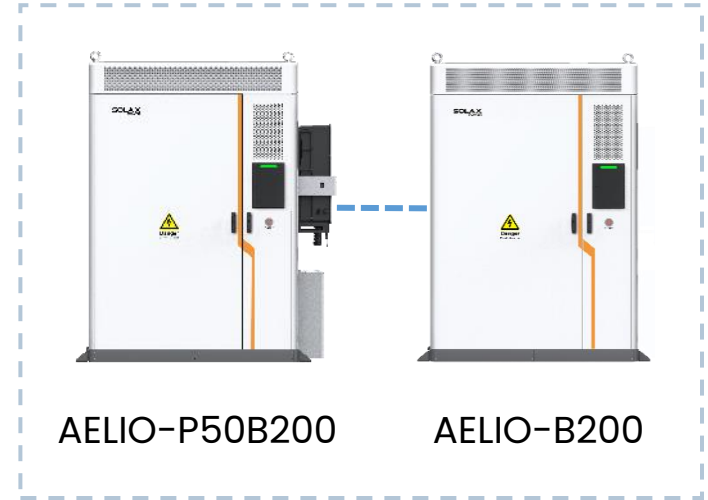
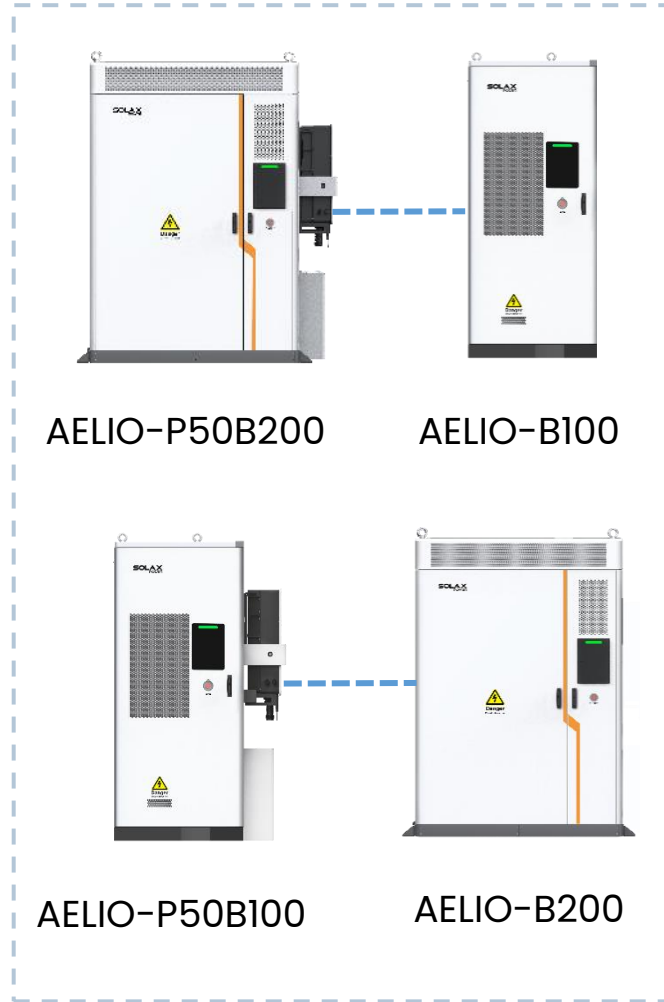
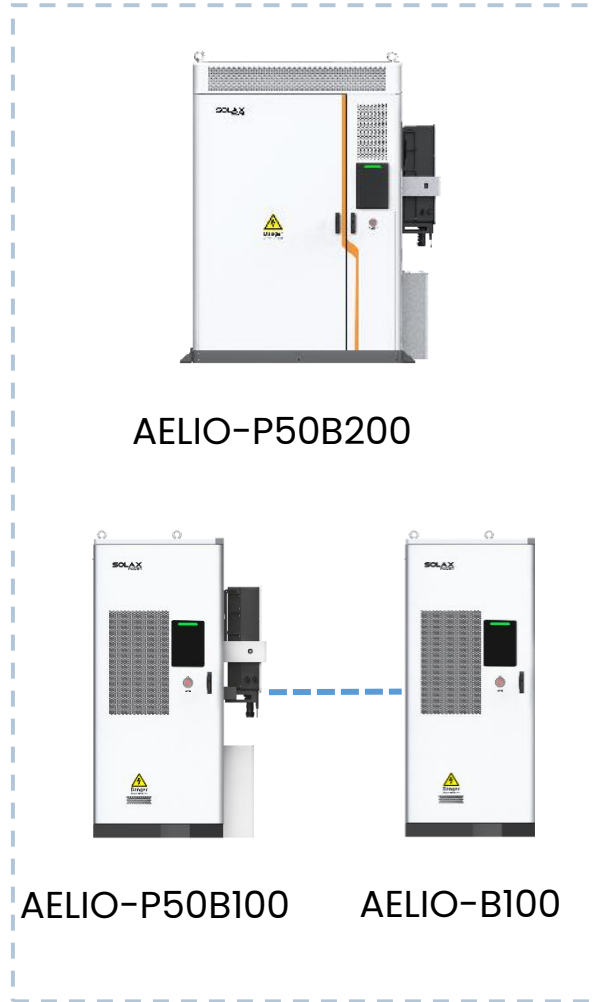

Air Cooling Intelligent Energy Storage System Design for C&I

X3-AELIO Hybrid Inverter + TB-HR140 Battery Racks
Flexible standalone solution



TB-HR140

- T-BAT HR1000: 7xTB-HR140
- T-BAT HR1140: 8xTB-HR140
- T-BAT HR1280: 9xTB-HR140
- T-BAT HR1430: 10xTB-HR140
- T-BAT HR1570: 11xTB-HR140
- T-BAT HR1710: 12xTB-HR140
- T-BAT HR1850: 13xTB-HR140
- T-BAT HR2000: 14xTB-HR140



X3-AELIO-50K
X3-AELIO-60K



EMS1000



Pocket Wi-Fi



System Overview

- All-in-one Integrated design
- One-stop solution

Various application scenarios

- Micro-grid supported
- VPP dispatch supported
- Warehouse, Factory, Mall etc
- Charging station

Superior capacity

- 280AH LFP battery
- 200 kWh capacity
- Expandable to MWh

All-in-one design

- Fast & simple installation
- Effortless O&M

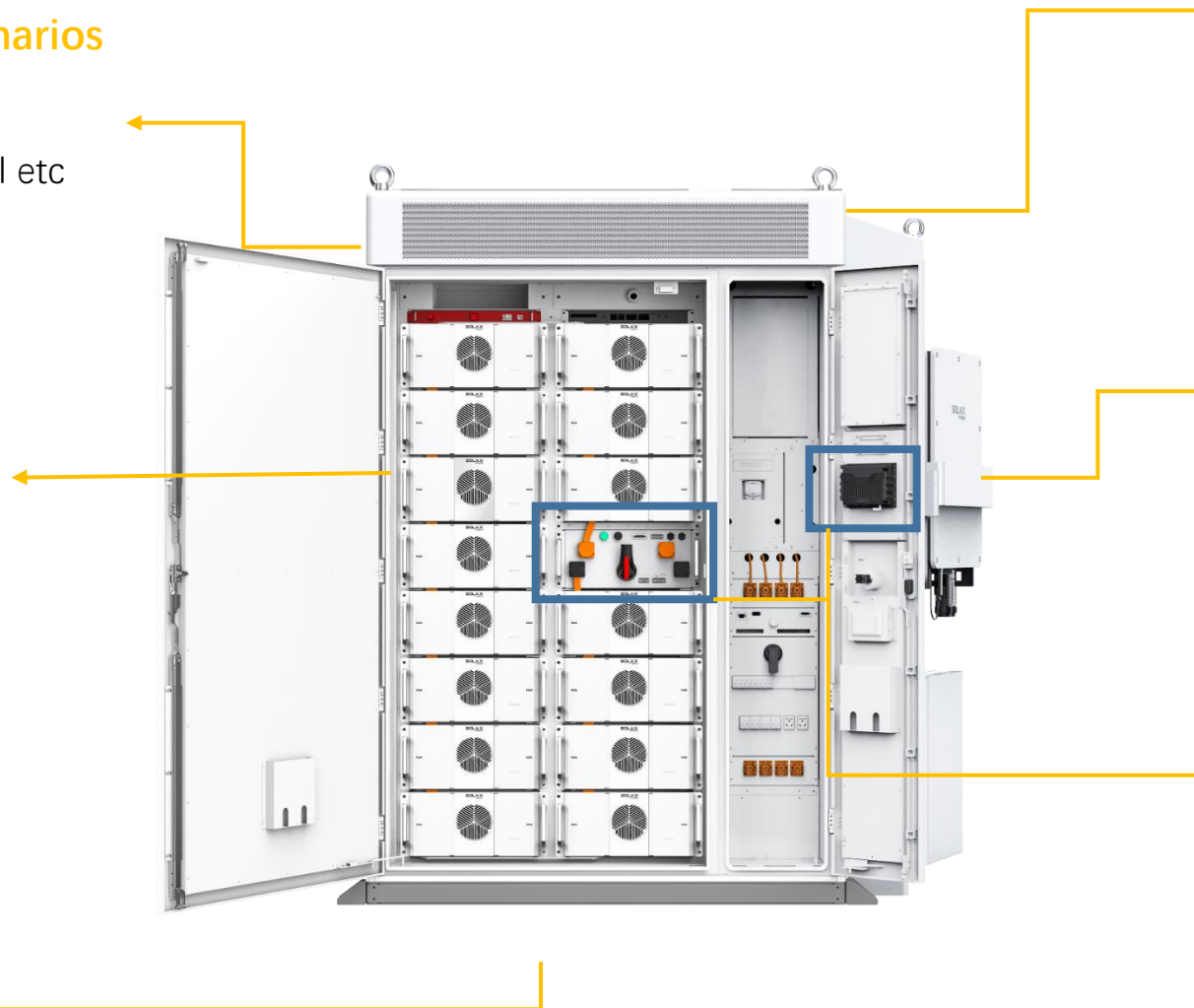

Robust safety

Air cooling module

- Cell temperature difference < 10°C
- Four-level fire protection

High versatility

Inverter

- 50kW/60kW, max 66kW output
- 6 MPPTs, 200 oversizing, 20A input
- 180V low starting voltage
- 10ms on-grid/off-grid switching
- Three-phase unbalanced output
- Support SVG
- 3P4W system
- Dual battery DC ports

Intelligent energy management

- Self-development EMS&BMS
- Solax Cloud & APP
- Smart Schedule & Smart scene
- cell level data real-time monitoring
- local data retention up to 1 year

Multiple Scenarios



Farms



Factories & Malls



Charging stations



Island micro-grid

Designed for industrial and commercial scenarios

Fast & simple installation

✓ Only **one hour** install to complete the whole solution

Simple wiring

Connect only grid and communication wires



Quick connectors

3P4W design compatible for all your 1P and 3P loads

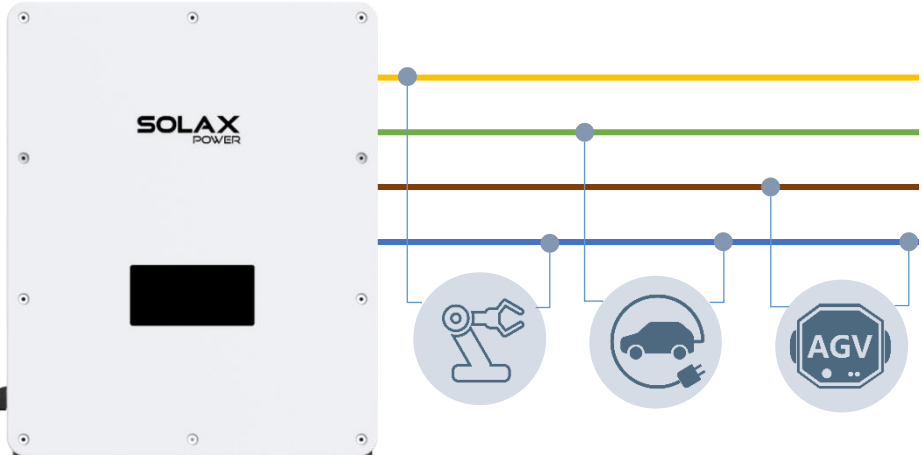

Wireless network

Paired with wireless bridge to access network fast



On-grid Off-grid

Nominal output power*	60kW	➔	60kW
Transformer			

Highly versatile Inverter

Multi-orientation Energy Harvesting

- Max. PV input current 20A per MPP , maximizing energy utilization to achieve higher electricity generation and improve overall system efficiency.

- 6MPP trackers for multi-orientation installation, easily expand or reconfigure your solar system without compromising energy generation efficiency.



SolaX 6MPP

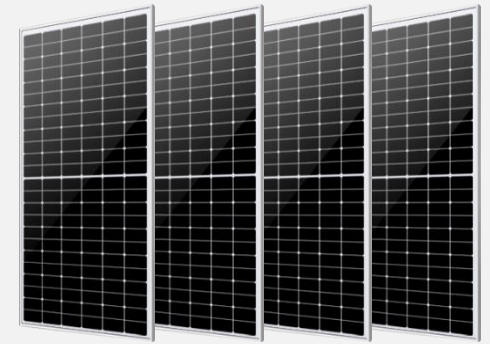

Others 4MPP

Highly versatile Inverter

Superior overload capacity

200% PV oversizing and 110% AC overloading

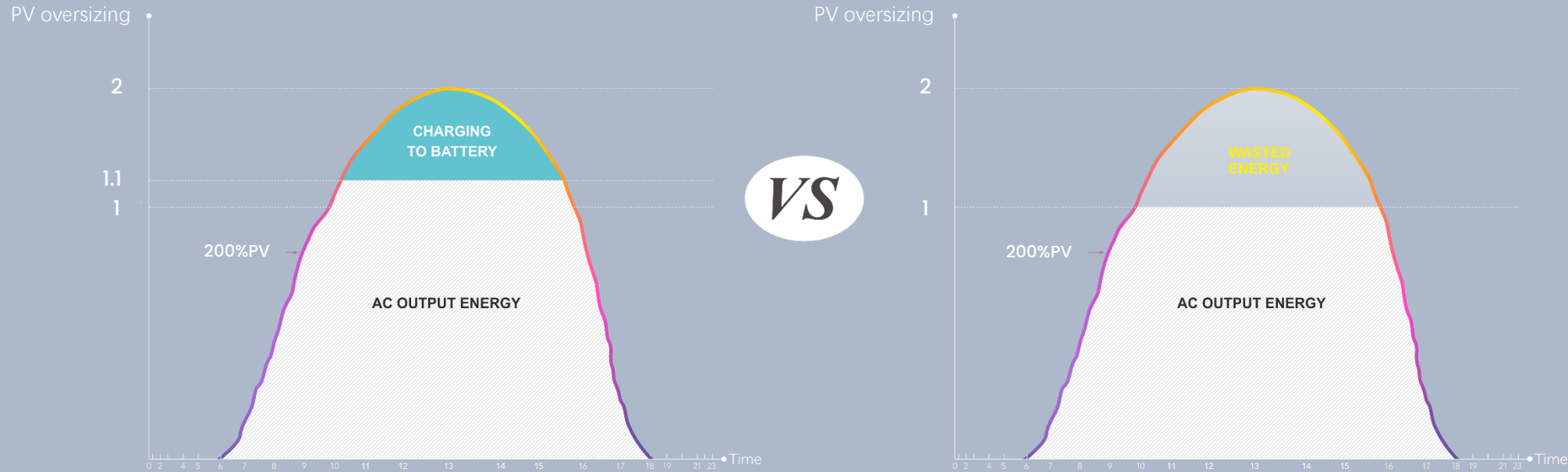

With the capability to handle 200% PV oversizing , ESS-AELIO increases power output even in cloudy conditions. Up to 110% long-term overloading and 150% AC instantaneousoverloading capacity enables ESS-AELIO to handle versatile residential & commercial & industrial loads.

Highly versatile Inverter

Strong Ability Against Unstable Grid

No Worries for Power Breakdown



Switch to emergency supply within 10ms

Micro-grid Supported



Enable string inverters to harness PV even during outages

Generator Supported



Power your load with generator

Highly versatile Inverter

Maximizing self-use electricity

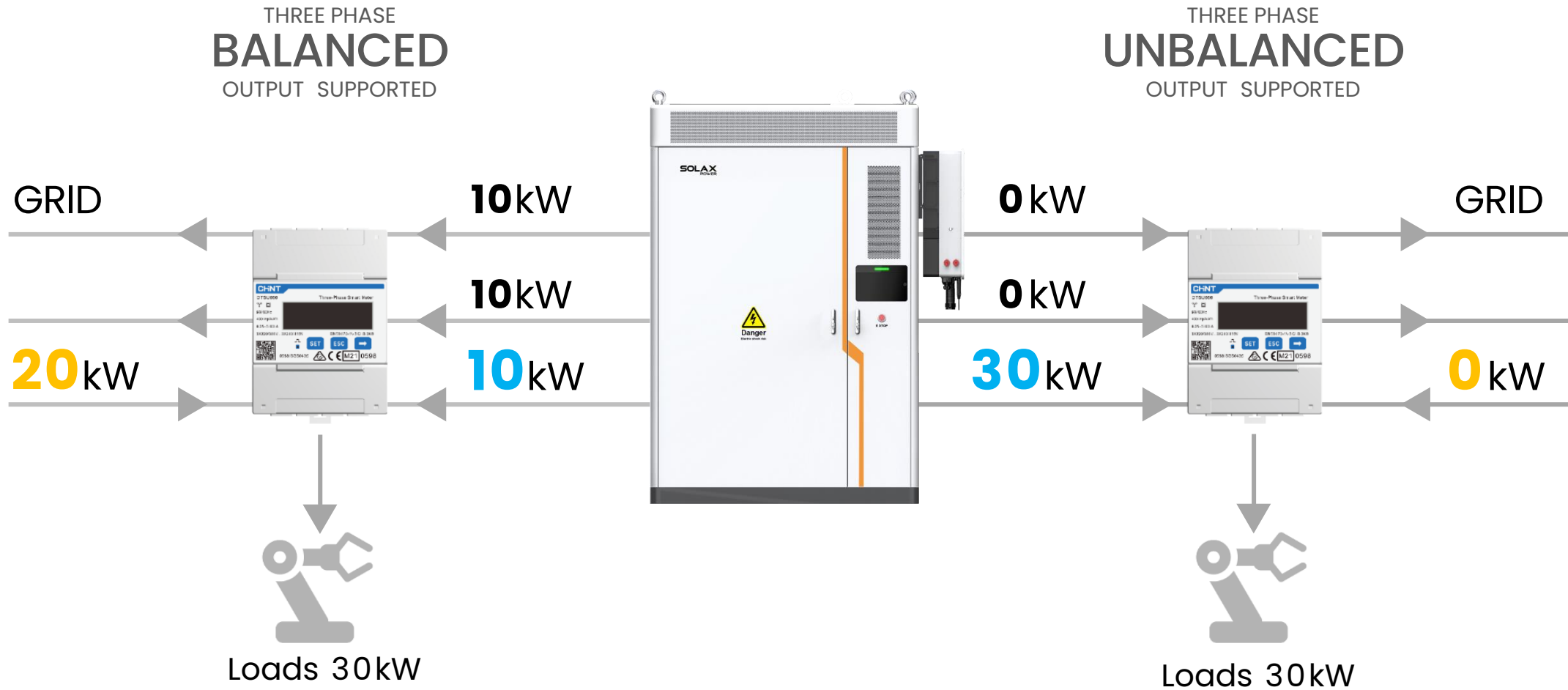

- Loads less than 30 kW, no need to buy electricity from the grid
- Prevent voltage imbalance when using high-power electrical appliances.

Highly versatile Inverter

Flexible and Expandable, all as you need

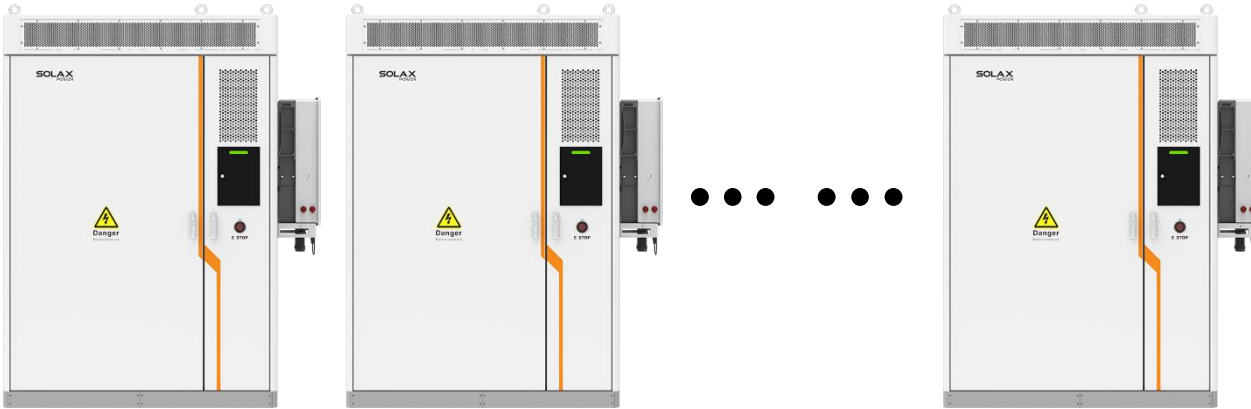

Support maximum **10+** units in parallel

- Larger power capacity meets the demands of a broader range of industrial and commercial scenarios
- **Dual** battery DC ports can be paralleled or working independently with more flexible energy expansion possibilities

Industry-leading battery

Robust safety guards maximized energy

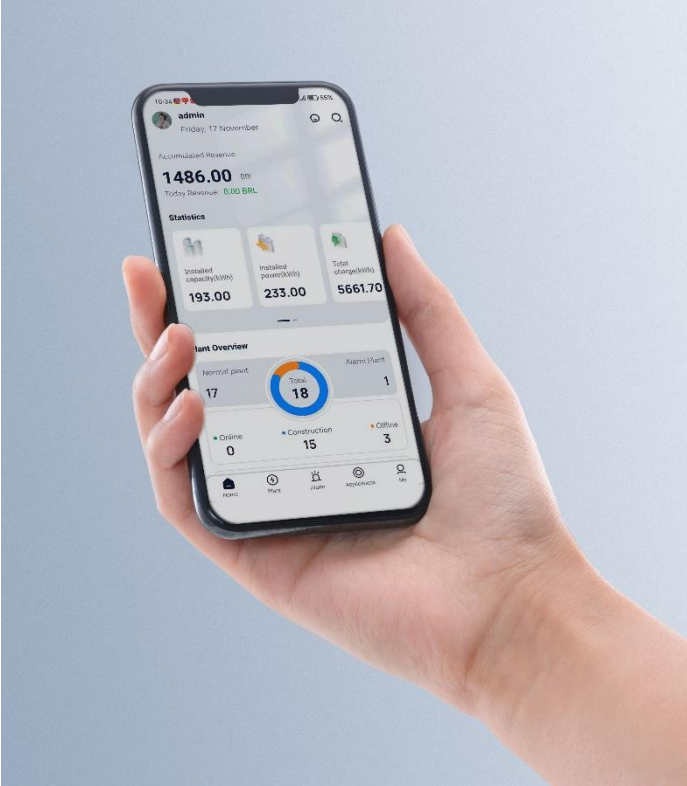

Cell level real-time monitoring

Remote view voltage, current, temperature, SoC, daily production and historical data at any time



Advanced battery management unit

Developed and Manufactured by SolaX, BMU embraces advanced hazards detection and earliest protection to enhance the Battery system

Higher energy density – LFP battery
Larger capacity – 280Ah, 200kWh stand-alone capacity

Four-level safety design

1. Multiple sensors real-time monitoring to trigger early warning

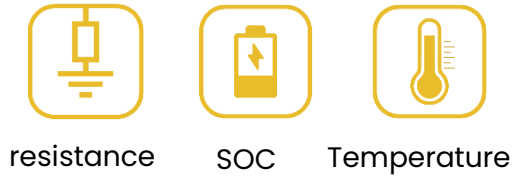
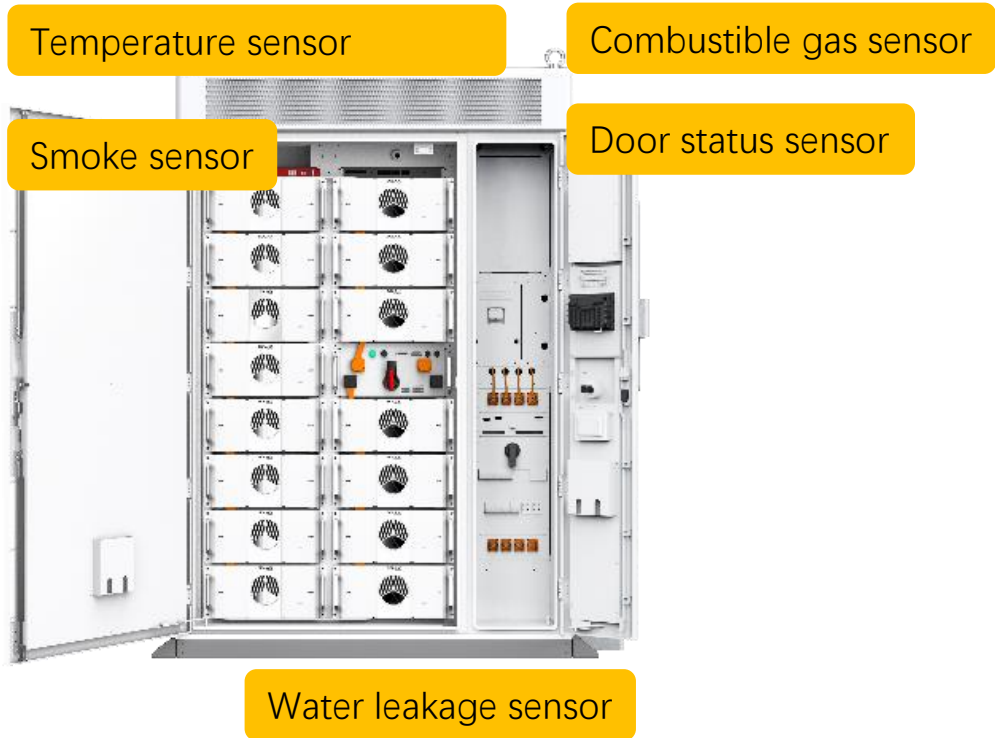

AI monitoring of Cell health
based on sensing technology

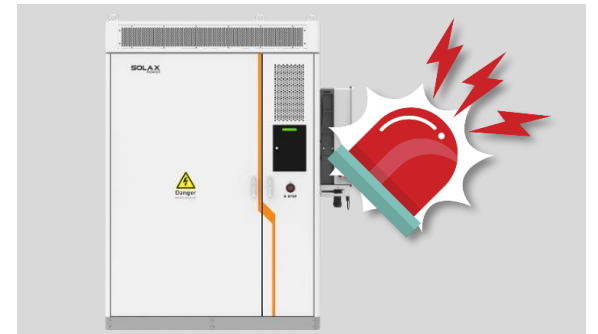

Four-level safety design

2. Multistage breaking designed for severe faults

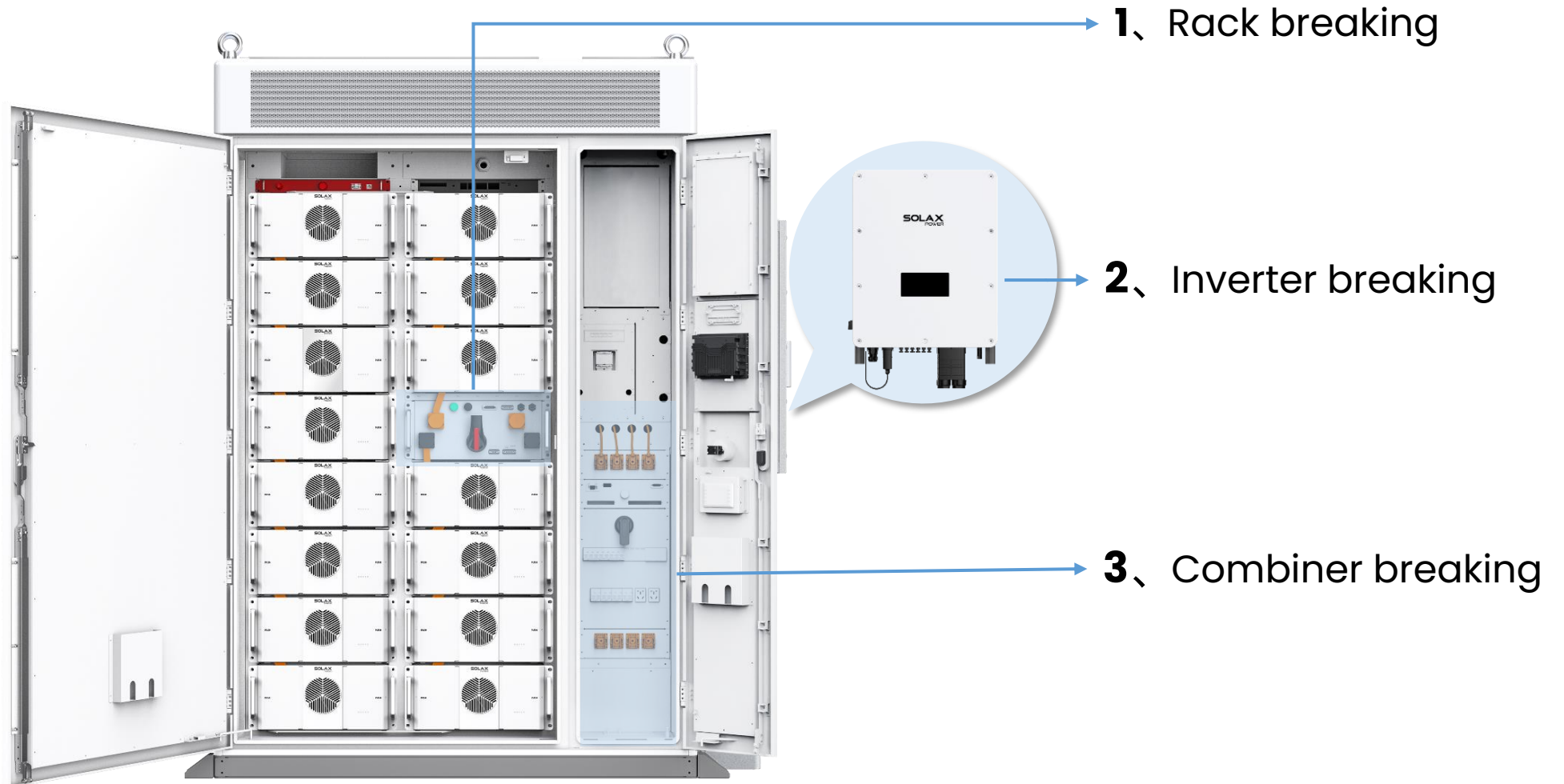

accurately identify the severe faults and automatically break the circuit to reduce the loss

Rack breaking -> PCS breaking -> Combiner breaking

Four-level safety design

3. Aerosol and water spray fire-extinguishing, dual fire protection safeguards



Four-level safety design

4. Compartmentalised design ensure bulkheads capable of enduring fire for 1.5h



scorching desert



ice and snow



storms and thunderstorms



high altitude

Compartmentalised design effectively slow the spread of the fire

Intelligent energy management

Smart Schedule – Effortless maximize energy efficiency

Smart Schedule

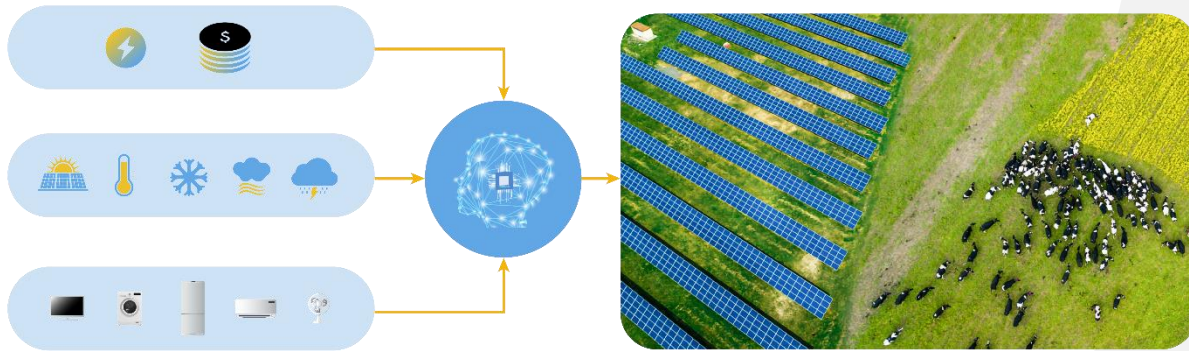

Auto tune to an optimal working mode based on deep-learning weather forecasting, usage habits, and electricity pricing in order to maximize energy efficiency.

Satisfying various application scenarios



On the farm, the Smart Scene takes into account weather conditions, including light radiation & temperature and operational requirements at specific times, while meeting the demands of loads such as water pumps and greenhouse lights, effectively optimizing energy usage.

Intelligent energy management

7X24 Time of Use — Customized & Bill Saving

- Set specific work modes for **each hour of the day, 7 days a week**; the weekly plan can be repeated.
- **Various work modes** to choose from: Self-Use/Battery Off/Peak Shaving/Charging/Discharging.
- **Holiday import** supported.
- **Bulk deployment** supported (coming soon).

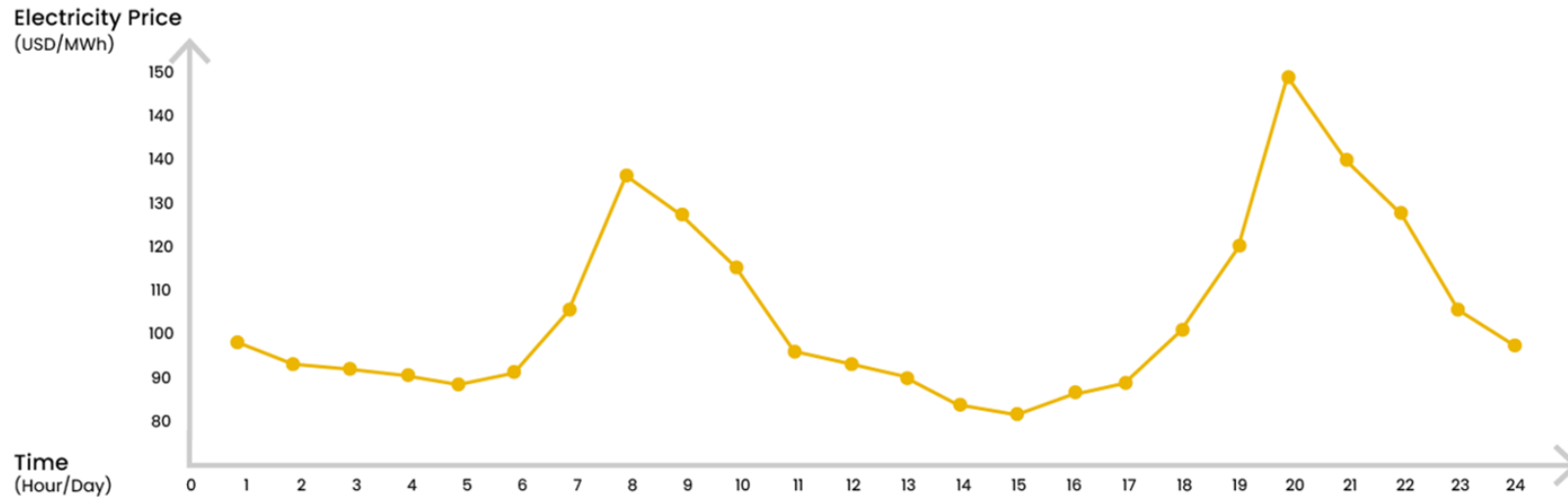

Previously Only one mode per day

ToU Set specific work modes to meet your needs, down to the hour, 24/7.

*Each color stands for a work mode



Satisfying various application scenarios

- Supermarkets

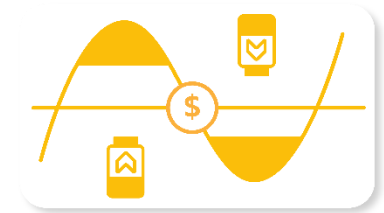
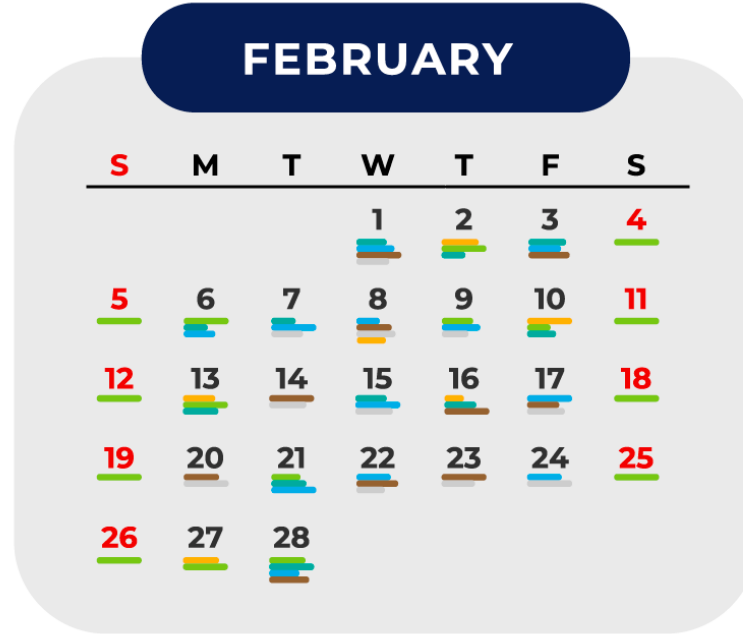

- Self-Use Mode
- Battery off
- Peak Shaving
- Charging Mode
- Discharging Mode

By setting different work modes for opening and closing times, TOU function enables shopping malls to save electricity during peak hours during working time.

Intelligent energy management

Smart scene – Define customized solution by your own

Smart Scene

Smart Scene innovatively **offers a customizable set of IF-THEN conditions and actions**, allowing users to create intelligent scenarios like automatically charging/discharging the battery based on preset conditions, making your life easier.



✓ Efficient



✓ Automatic



✓ Money saving

Example

IF - What you SET

IF condition is set at 2 AM, and the weather forecast predicts rain within the next 8 hours.



Forecasted raining tomorrow

EMS100



Then - What you GET

In response to this condition, the THEN action is programmed to charge the battery to 100% at 2 am, when the electricity price is typically lower.



Auto Charging

Satisfying various application scenarios



IF



Solar Radiation > 450
&



Electricity Price > 0.3 EUR



feed-in priority mode



Time is 22:00
&



Electricity Price < 0.3 EUR



Turn off charging pile

Then

Intelligent energy management

Support power VPP dispatch

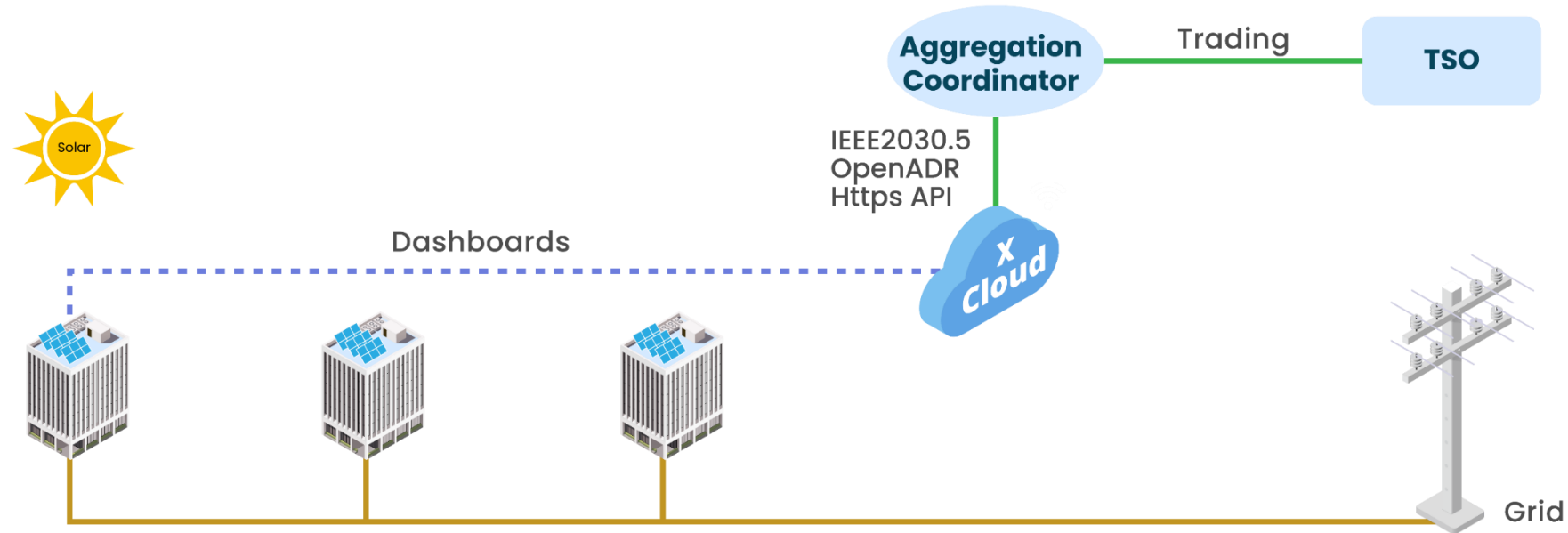

- VPP, also known as Virtual Power Plant, is a network of decentralized energy-generation systems, like solar systems, that are linked together and managed by a VPP operation platform.

- With support for API / IEEE2030.5 and Open ADR, our product can easily integrate with VPP operation platforms. This functionality is currently being utilized in certain countries.

Application Systems | Common Loads

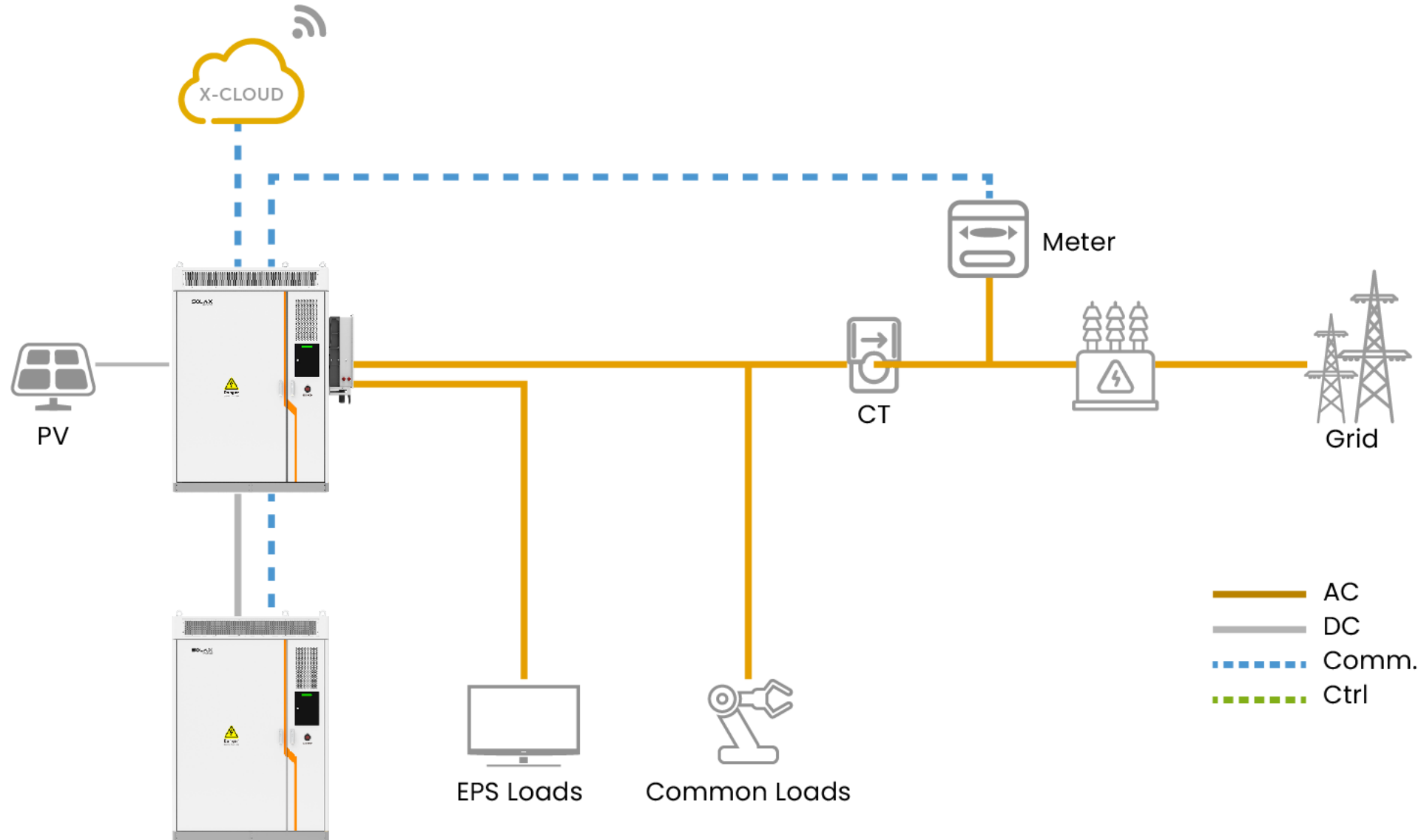

Application Systems | In Parallel

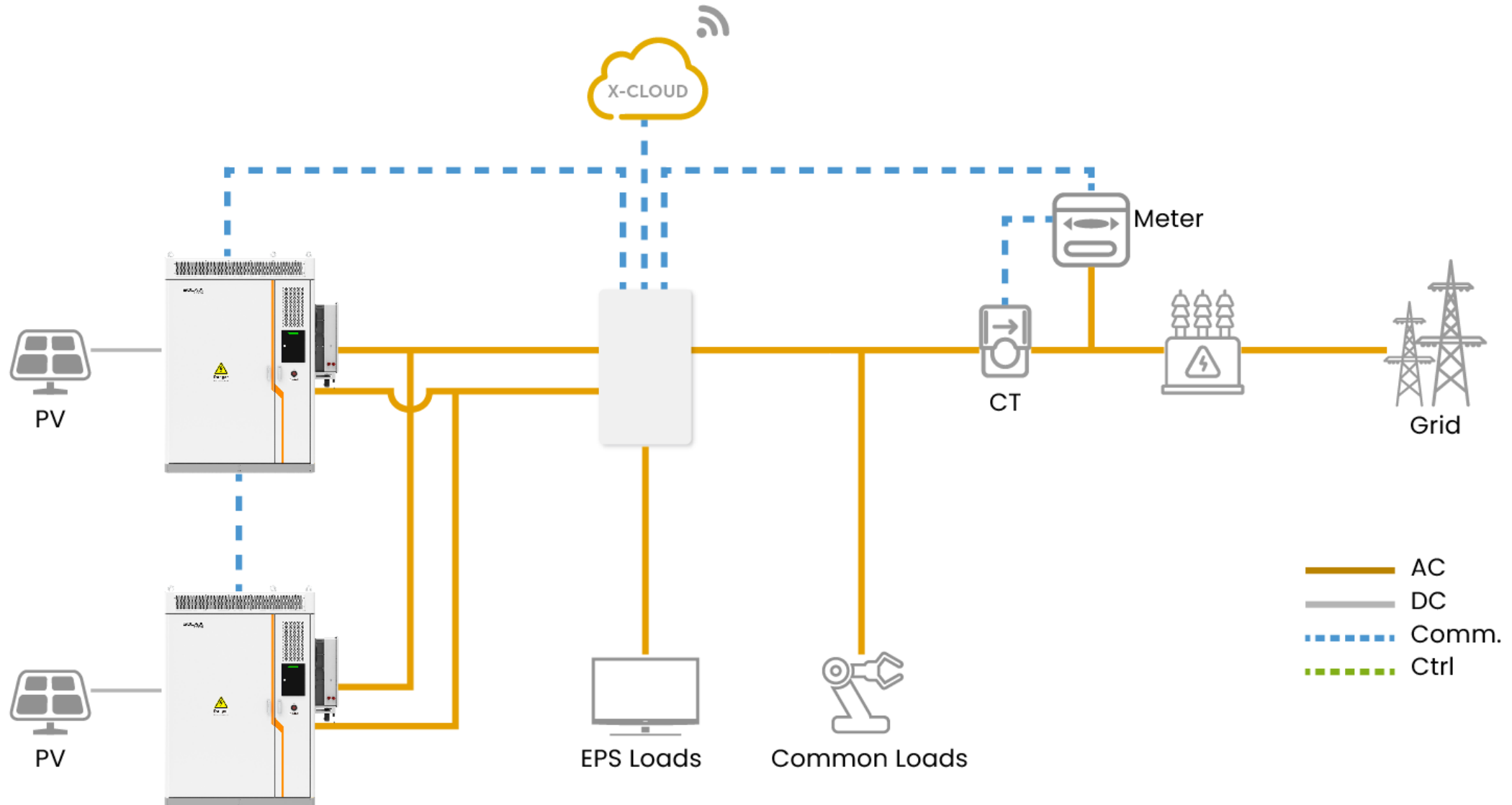

Application Systems | Micro Grid

Together with an on-grid inverter and a PV system, forming an independent micro-grid enables island energy self-use.

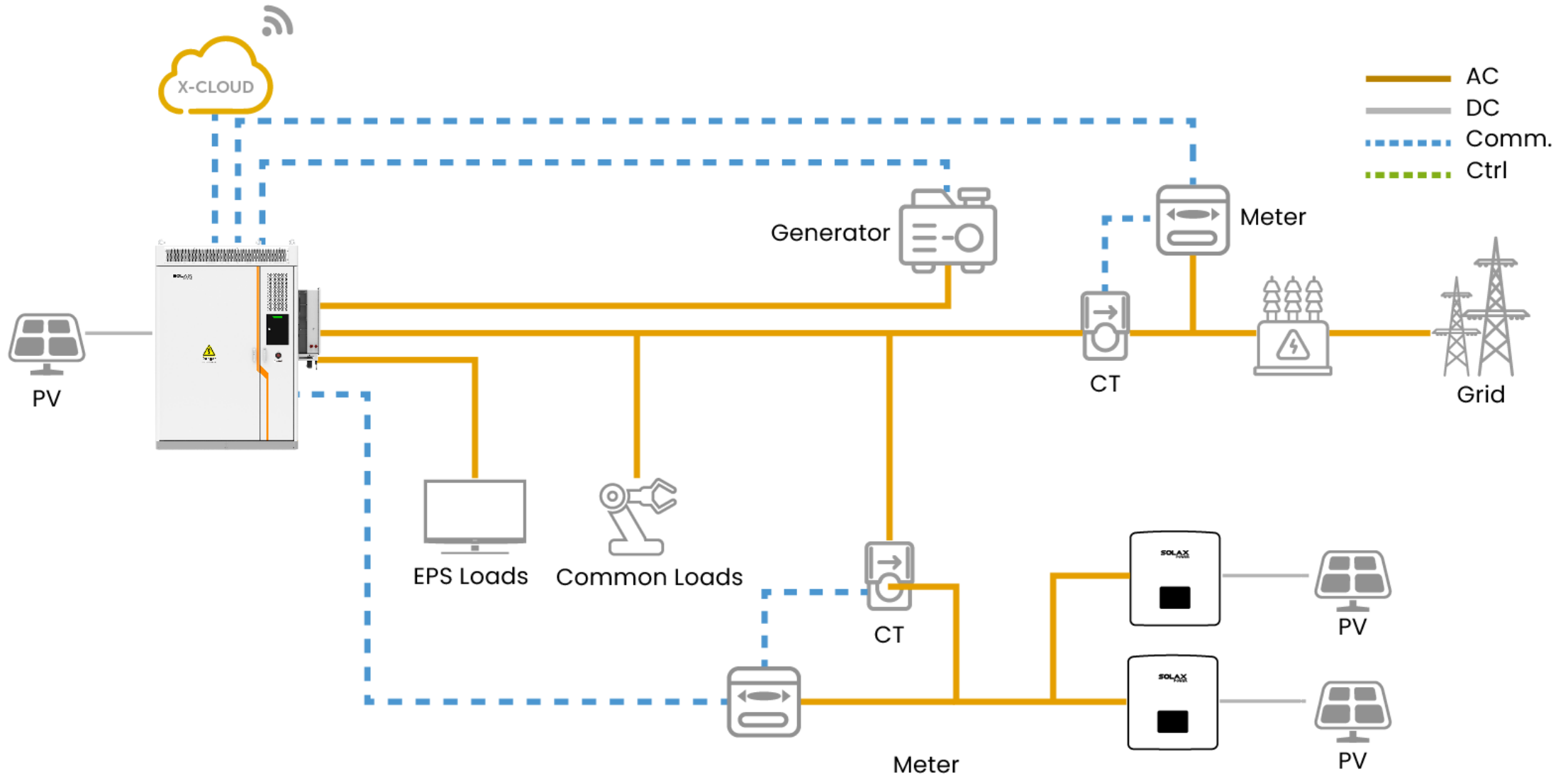

Application Systems | EV Charger

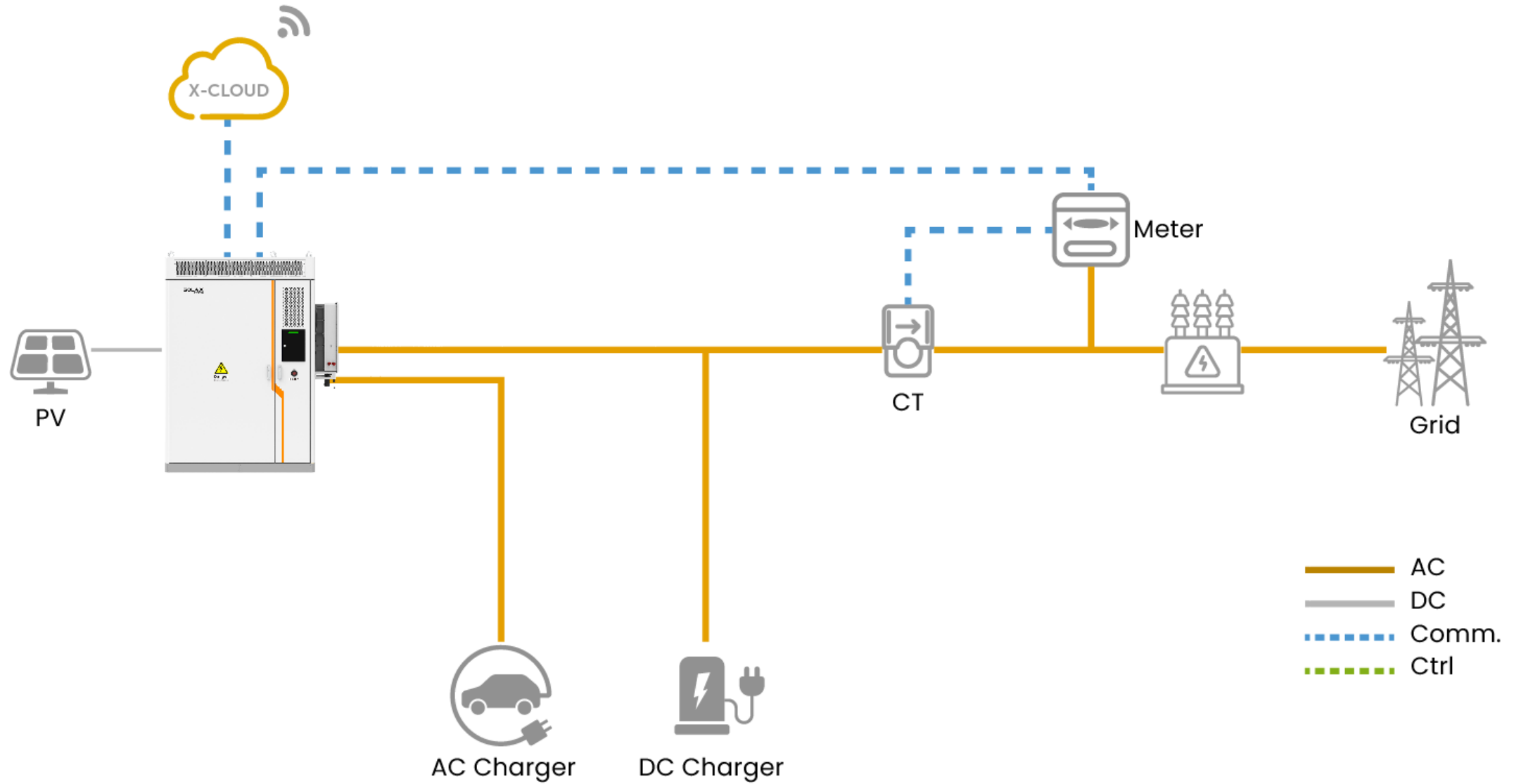

Effortless O&M

Remote control and upgrade ensures convenience



OTA upgrade



Wireless control

SolaX Cloud - One-Stop Power Management Platform



- 10 sec Real-time data refresh
- Consumption monitoring
- Intuitive interface
- dashboard supports customization
- Apps are available on Google Play & App Store

Global Service Support

- All products are solely-developed and self-manufactured by SolaX, including hybrid inverters, storage batteries, BMS.
- From R&D to manufacturing, from sales to after-sales support, you can trust us for high-quality products and services.



200kWh stand-alone capacity

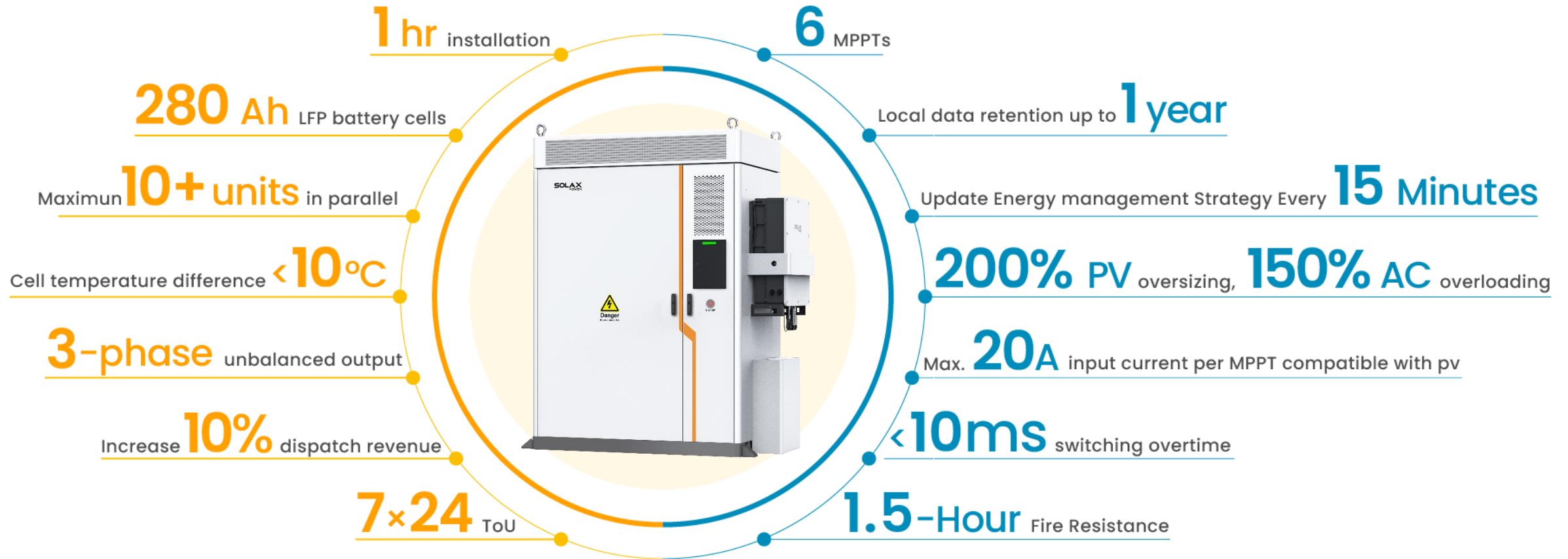

Technical Parameter

System model	AELIO-P50B100	AELIO-P50B200
Basic Parameter		
Protection class	IP54	
Operating temperature range [°C]	-30 ~ 55	
Max. operation altitude [m]	< 3000	
Relative Humidity(non-condensing) [%]	0 ~ 95	
Dimensions (WxHxD) [mm]	1280 × 2300 × 1150	2067 × 2420 × 1100
Weight (kg)	1600	2800
Cooling Concept	Smart air cooling	
Fire Suppression system	Optional: Aerosol / Novec1230 / Water	
Display	LCD (Optional)	
Communication Interface	Ethernet / 4G / CAN / USB	
Topology	Non-isolated type	
Certification	IEC621619, IEC63056:2000, IEC61000-6-2&-6-4, IEC62477-1, UN38.3	

Technical Parameter

System model	AELIO-P50B100	AELIO-P50B200
INPUT (DC)		
Max. input power [kWp]	100	
Max.DC voltage [V]	1000	
Nominal DC operating voltage [V]	650	
MPPT voltage range[V]	160 ~ 950	
No. of MPP trackers	5	
Strings per MPP tracker	2	
Max. input current per MPPT [A]	40	
Max. short circuit current per MPPT [A]	50	
OUTPUT AC		
Nominal output power [kW]	50	
Max. apparent AC power [kVA]	55	
Max. AC current [A]	83.6	
Nominal grid voltage [V]	400 / 230V, 380 / 220V	
Nominal grid frequency [Hz]	50 / 60	
Maximum charge / discharge power [kW]	50	
Adjustable range of power factor	1 leading ~ 1 lagging	
THD[%]	< 3	

Technical Parameter

System model	AELIO-P50B100	AELIO-P50B200
BATTERY		
Cell type	LFP / 280Ah	LFP / 280Ah
System configuration	1P112S	1P224S
Nominal voltage [d.c.V]	358.4	716.8
Battery voltage range [d.c.V]	280 ~ 408.8	560 ~ 817.6
Nominal capacity [kWh]	100	200
Nominal power [kW]	50	50
PROTECTION		
Anti-islanding protection	Yes	Yes
AC overcurrent protection	Yes	Yes
DC reverse-polarity protection	Yes	Yes
Insulation resistance detection	Yes	Yes
Over/under voltage protection	Yes	Yes
Over temperature protection	Yes	Yes
SPD (DC/AC)	Type II/Type II	Type II/Type II

THANKS

Powering a Green Future

Global: +86 571-56260008

www.solaxpower.com

info@solaxpower.com

The logo consists of the words "SOLAX" and "POWER" in a bold, blue, 3D sans-serif font. The letters are stacked and slightly offset, creating a sense of depth and movement. The background features a faint, light blue grid pattern that recedes into the distance, suggesting a modern, technological environment.